

VEM

Válvula de Esfera Monobloco 1000 WOG



Disponível também com furo de alívio para utilização em manômetro

Válvula de Esfera Monobloco Latão Forjado



Opção Alavanca Tipo Borboleta

Válvula de Esfera Monobloco Latão Forjado PN 25 - DNR



Válvula de Esfera Monobloco Latão Forjado PN 40 / Gás



Opção Alavanca Tipo Borboleta

Válvula de Esfera Bipartida Flange Classe 150

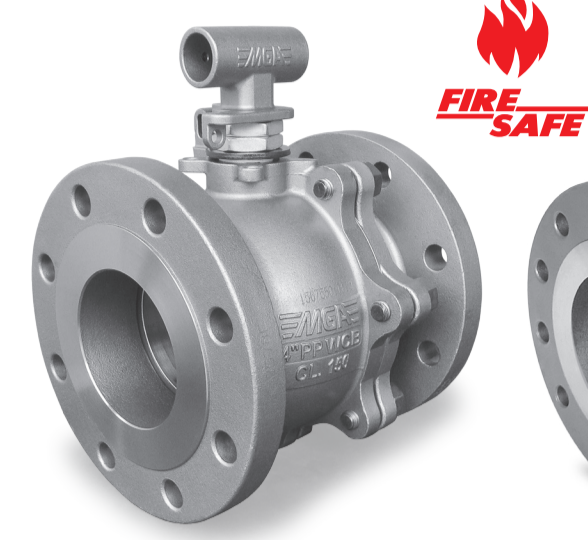

Válvula de Esfera Bipartida Flange Classe 300

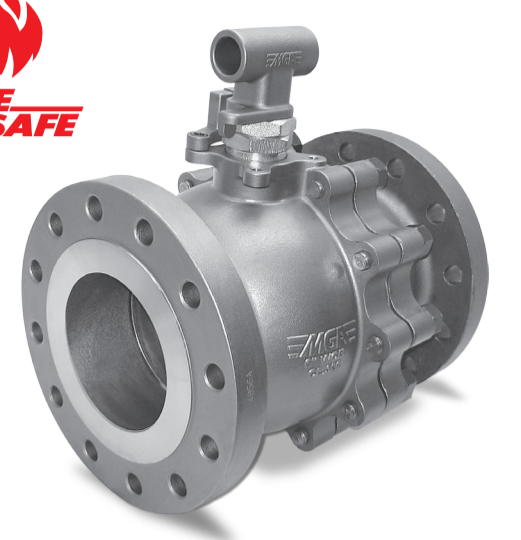

Disponível com sedes de vedação metálica.

Válvula de Esfera Monobloco Latão Forjado Mini



Válvula de Esfera Monobloco para Fundo de Caldeira Classe 150 / 300

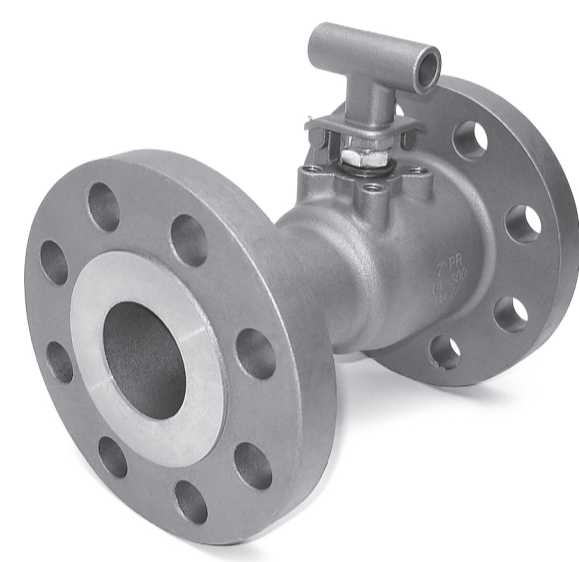

Válvula de esfera Wafer Classe 150



Válvula de esfera Wafer Flangeada Classe 150

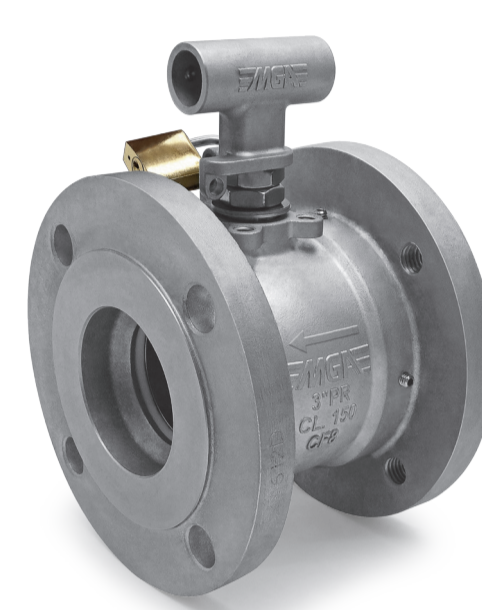

VEB

Válvula de Esfera Bipartida Duplex e Super Duplex

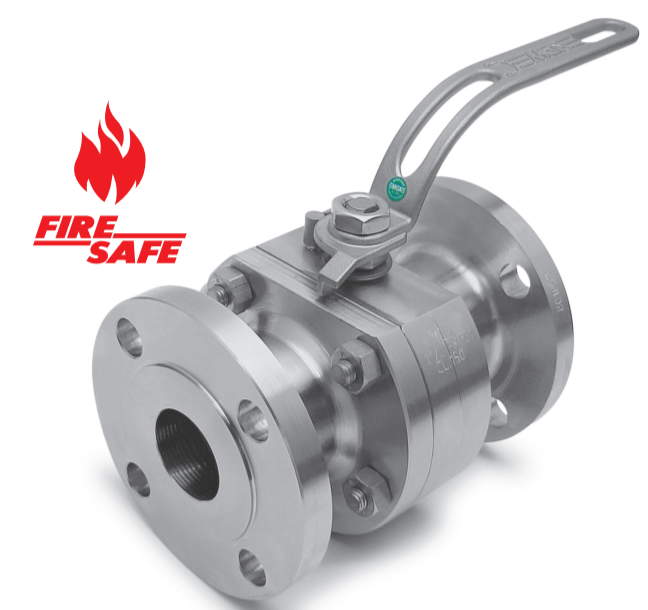

IMAGENS MERAMENTE ILUSTRATIVAS

VET

Válvula de Esfera Tripartida Classe 300



Válvula de Esfera Tripartida Latão Forjado



Válvula de Esfera Tripartida 400Psi com Conexão para Tubo OD



Válvula de Esfera Tripartida com Dispositivo Retorno Mola

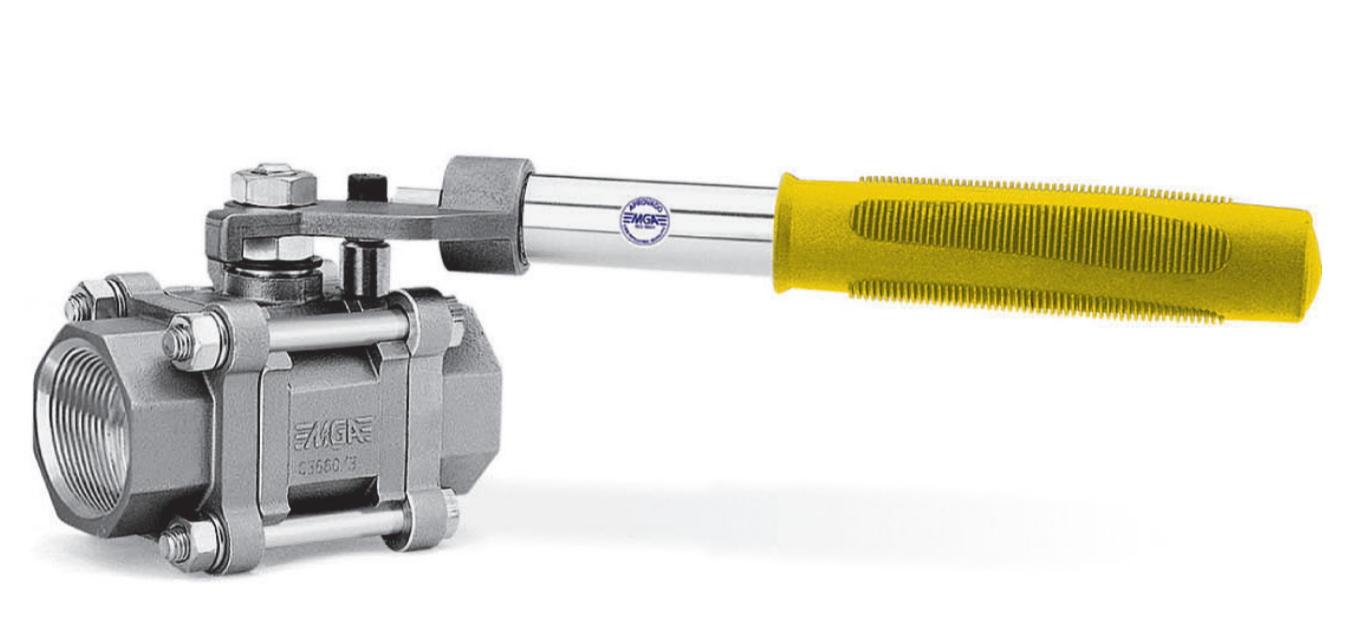

Válvula de Esfera Tripartida Forjada Classe 800



Válvula de Esfera Tripartida Trunnion Classe 1500

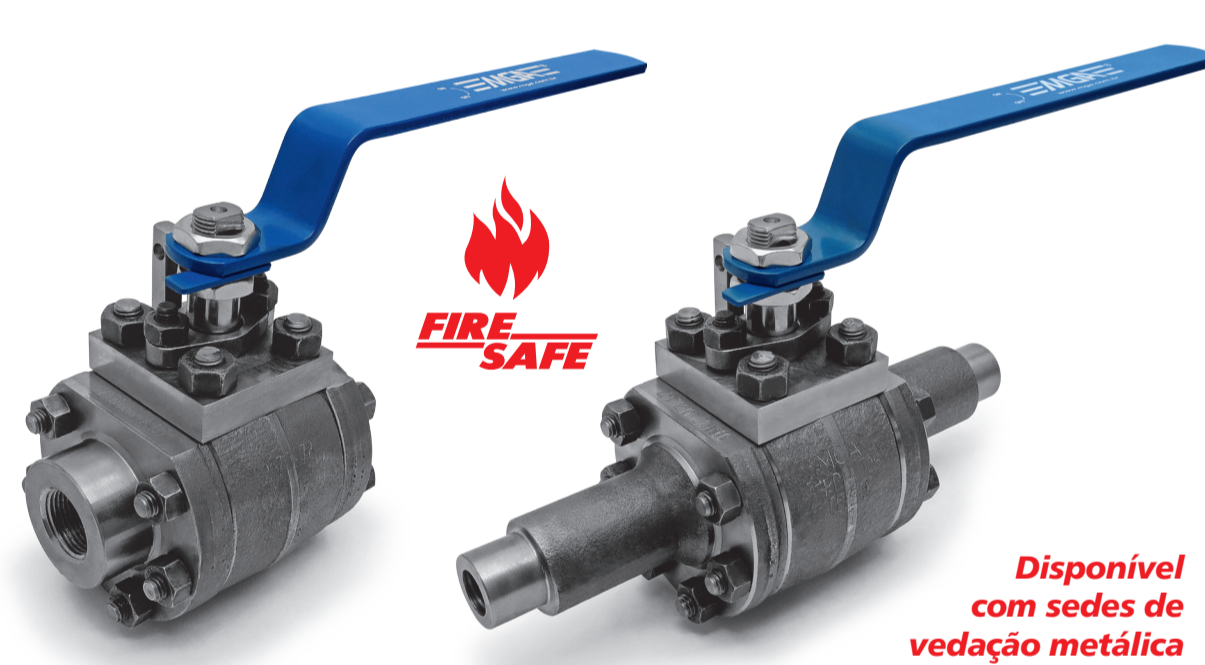

Válvula de Esfera Tripartida Trunnion Classes 150 a 1500



Válvula de Esfera Tripartida Flange Classe 150



Válvula de Esfera Tripartida Série 1000 Classe 300

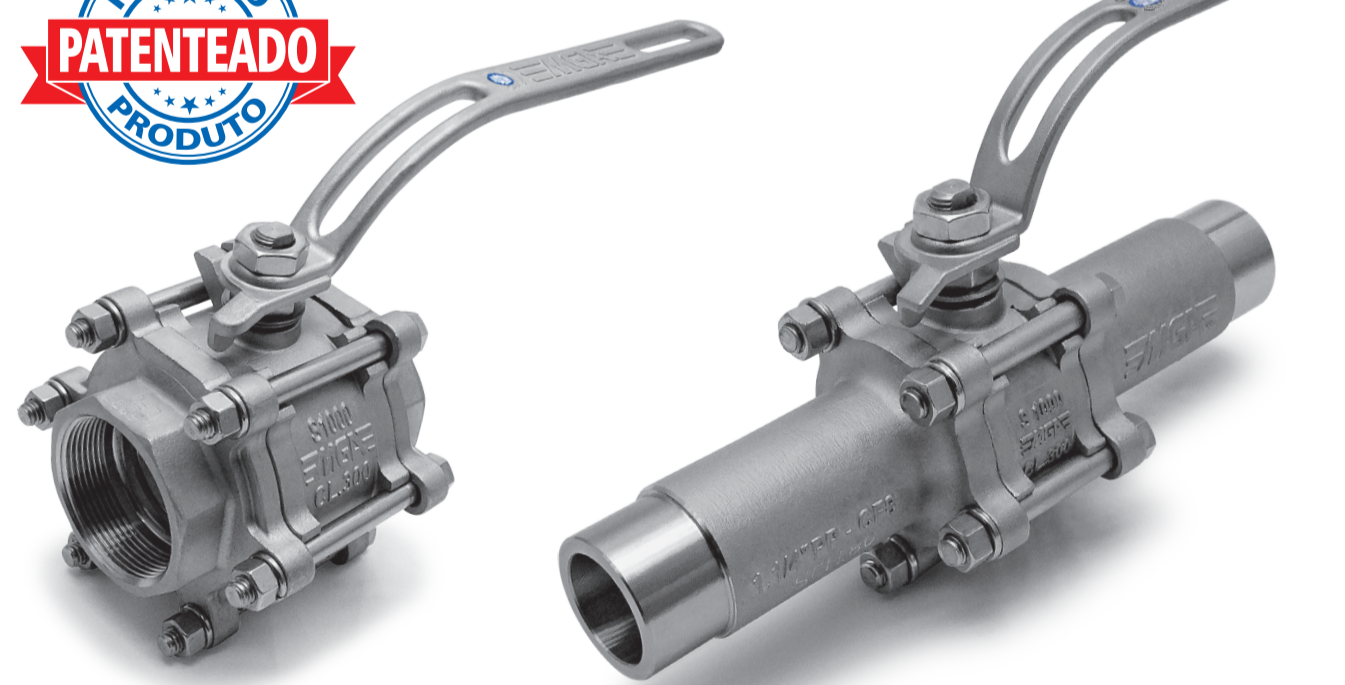

Válvula de Esfera Tripartida Série 1000 Flange Classe 300

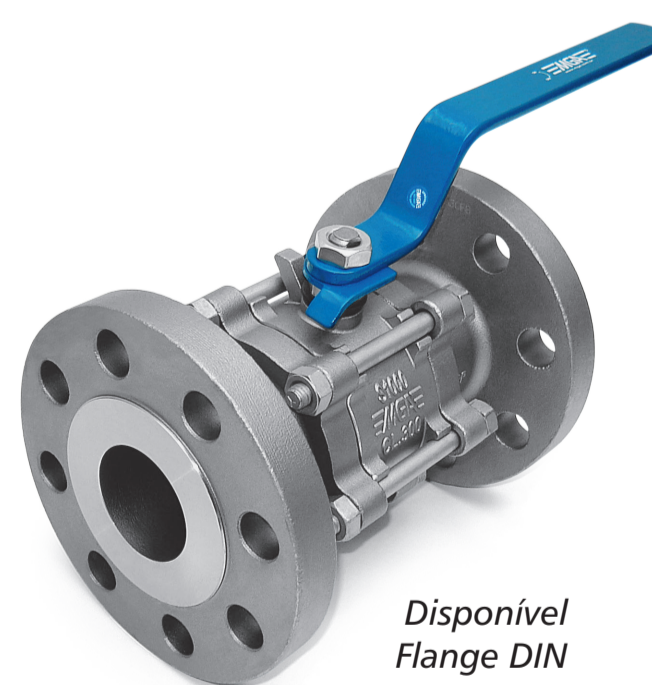

Disponível Flange DIN

VETD | Válvula de Esfera Direcional de Fluxo Flange Classe 150 / 300

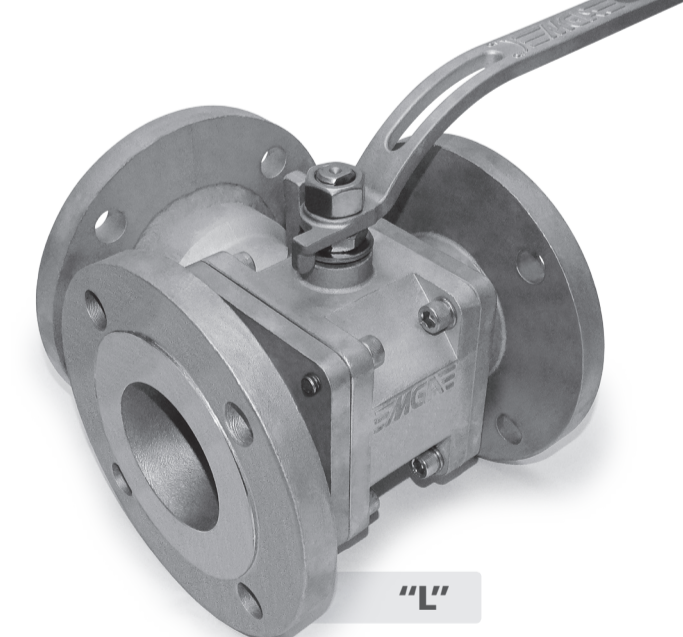

VETD - Válvula de Esfera Direcional de Fluxo Classe 300



DIVERSAS

VF - Visores de Fluxo



VED-M Válvula de Esfera Direcional Multivias



Válvula de Esfera com Cavidade Preenchida

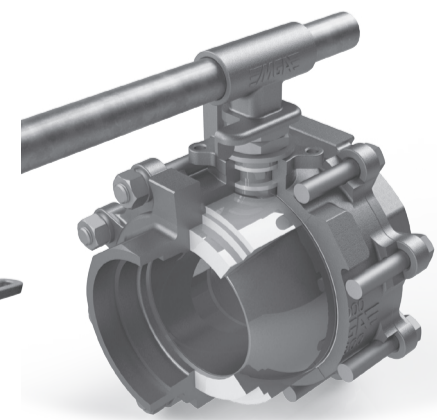

VB Válvula Borboleta Tipo Wafer Classe 150

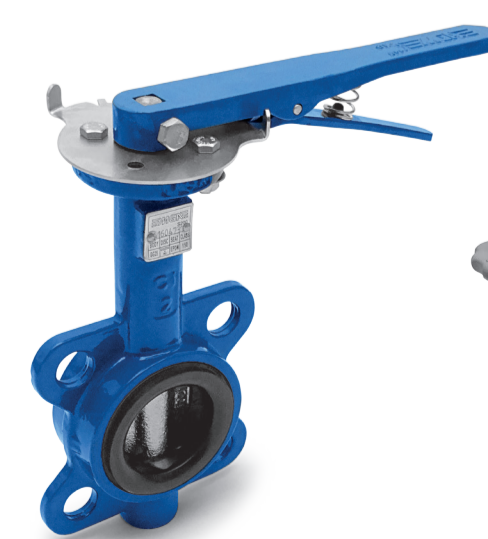

Válvula Globo Criogênica Classe 300



Válvula de Esfera Monobloco para Tambor



VG Válvula Gaveta Classe 150



Válvula Atuadora Eletricamente



Atuador Pneumático DA/SR



www.reuna.com.br